



VAHO GLASS



ES

MÍNIMO ESPACIO, MÁXIMO CONFORT

SV-X50 es un sistema de puerta corredera para duchas para paneles de vidrio sin marco que combina las últimas novedades tecnológicas con un atractivo diseño minimalista.

1. Perfil corredero de aluminio **compacto** que oculta todos los mecanismos dentro del mismo; consiguiendo así, un inmejorable aspecto estético. **2.** Disponible en **distintos acabados:** aluminio Inox repulido, aluminio pulido cromado, aluminio dorado cepillado y aluminio anodizado negro mate. **3. Montaje** pared-pared, pared-vidrio, vidrio-vidrio y angular (90°) **4.** Apto para **grosos de vidrio** de 8 y 10mm (8mm para angular). **5. Instalación fácil y rápida** gracias al acceso frontal a todas las regulaciones y componentes. **6. Rodamiento a bolas** para para una acción deslizante suave y segura. **7. Sistema de amortiguación SofTop doble:** gracias a la nueva tecnología de amortiguación recientemente desarrollada, el esfuerzo de apertura será mínimo, ya que conseguimos reducirlo hasta casi un 40%. Asimismo, tendremos un frenado suave y silencioso en los últimos 7cm del recorrido de cierre. El sistema de amortiguación SofTop doble, protegerá al sistema de daños por impacto, alargando así la vida útil del producto y con solo un mínimo de ancho puerta necesario de 630mm. **8. Certificado Applus+:** Grado de durabilidad 6: 100.000 ciclos de ensayo y Grado de corrosión 4 = 240h según norma EN1527 **9. Accesorios opcionales:** vierteaguas horizontal y juntas de estanqueidad que se quitan fácilmente para limpiar y/o cambiarlas.

EN

MINIMUM SPACE, MAXIMUM COMFORT

SV-X50 is a frameless sliding glass shower door system that combines the latest technological developments with an attractive minimalist design.

1.Compact aluminum sliding **track** that conceals all the mechanisms; thus, achieving an unbeatable aesthetic appearance. **2.** Available in **different finishes:** brushed nickel aluminum, polished chrome aluminum, satin brass aluminum and matt black anodized aluminum. **3. Installation** wall-wall, wall-glass, glass-glass and angular (90°) **4.** Suitable for **glass thicknesses** of 8 and 10mm (only 8mm for angular) **5. Quick and easy installation** thanks to the frontal access to all components and its adjustments and regulations. **6. Ball bearing rollers** for a smooth and silent sliding action. **7. Double SofTop damping system:** thanks to the latest developed damping technology, the opening effort is minimal as it has been reduced by almost 40%. Likewise, a smooth and silent closing in the last 7cm of the sliding path is achieved. The double SofTop damping system protects the system from impact damage, thus extending the useful life of the product and with only a minimum door width of 630mm required. **8. Applus+ Certificate:** Durability grade 6: 100.000 test cycles and Corrosion grade 4 = 240h according to EN1527 standards. **9. Optional accessories:** horizontal water seals and sealing gaskets that can be easily removed for cleaning and/or changing.

FR

ESPACE MINIMAL, CONFORT MAXIMAL

SV-X50 est un système de porte de douche coulissante pour panneaux de verre sans cadre qui combine les dernières innovations technologiques avec un design minimaliste attrayant.

1. Profilé coulissant **compact** en aluminium qui dissimule tous les mécanismes à l'intérieur, ce qui lui confère un aspect esthétique incomparable. **2.** Disponible en **différentes finitions:** aluminium poli nickelé, aluminium poli chromé, aluminium doré brossé et aluminium anodisé noir mat. **3. Installation** mur-mur, mur-verre, verre-verre et angulaire (90°) **4.** Convient pour des **épaisseurs de verre** de 8 et 10mm (8mm pour l'angulaire) **5. Installation rapide et facile** grâce à l'accès frontal à tous les réglages et composants. **6. Roulement à billes** pour une action coulissante en douceur et sûre. **7. Double système d'amortissement SofTop:** grâce à la nouvelle technologie d'amortissement récemment mise au point, l'effort d'ouverture est minimum et réduit de près de 40%. De plus, nous aurons un freinage en douceur et silencieux dans les 7 derniers centimètres du parcours de fermeture. Le double système d'amortissement SofTop protège le système contre les dommages causés par les chocs, ce qui prolonge la durée de vie du produit. Une largeur de porte minimale de 630mm suffit. **8. Certificat Applus+:** Degré de durabilité 6: 100.000 cycles d'essai et degré de corrosion 4 = 240h selon la norme EN1527. **9. Accessoires en option:** gouttière horizontale et joints d'étanchéité qui peuvent être facilement retirés pour être nettoyés et/ou remplacés.



Montaje pared-pared | mounting wall-to-wall | fixation mur-mur



Características técnicas

Technical characteristics
Caractéristiques techniques

Tecnología y facilidad de montaje

Technology and ease of installation | Technologie et facilité d'assemblage

Perfilería Profiles | Profils



76x49mm



17x12mm

Especificaciones Specifications | Spécification

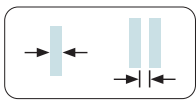

8 mm

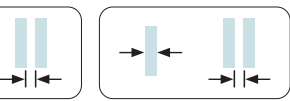

10 mm

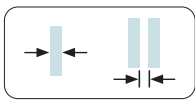

10 mm

OPCIÓN 90° |
90° OPTION | OPTION 90°

OPCIÓN 90° |
90° OPTION | OPTION 90°



MÍN.450 mm



SofTop Doble
MÍN.630 mm

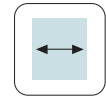

MÍN.450 mm
MÁX.750 mm



SofTop Doble
MÍN.630 mm
MÁX.750 mm



KIT DISPONIBLE
| AVAILABLE



RODAMIENTO A BOLAS
BALL BEARING
ROULEMENT À BILLES

Peso Weight | Poids

50 kg

110 lb

OPCIÓN 90° | 90° OPTION | OPTION 90°

30 kg

66 lb

Producto certificado

Certificaded product | Produit certifié



Grado de durabilidad 6:
100.000 ciclos de ensayo y
Grado de corrosión 4 = 240h. |
Durability grade 6: 100.000 test
cycles and Corrosion grade 4
= 240h. | Degré de durabilité 6:
100.000 cycles d'essai et degré
de corrosion 4 = 240h.

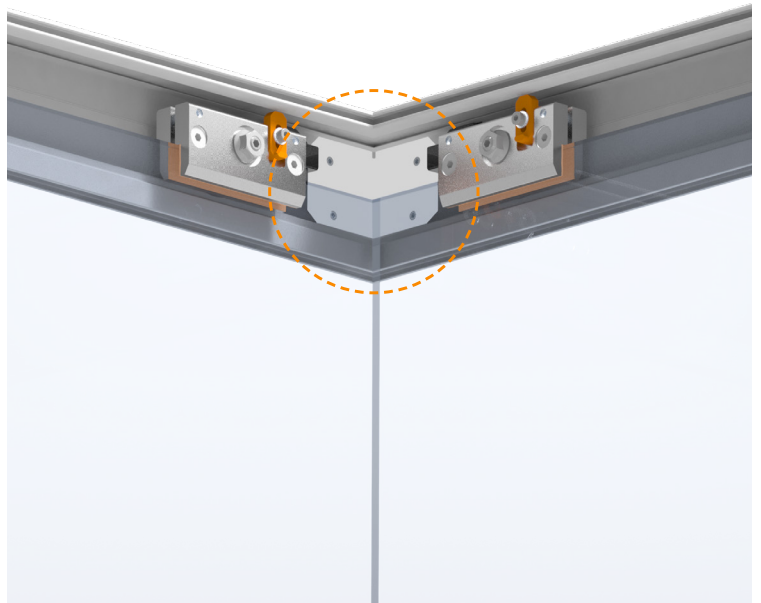
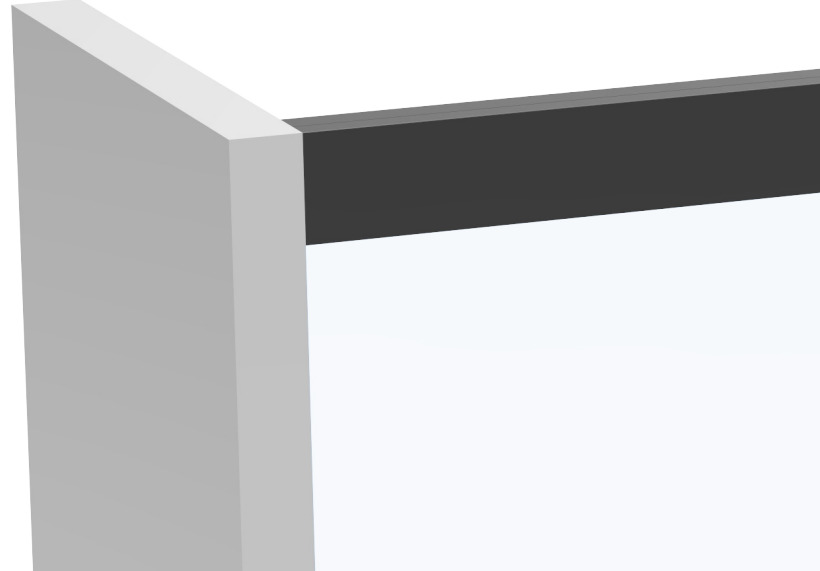

IESI Conector angular de fácil instalación ya que no requiere taladros. Diseñado para evitar la flexión del angular gracias a su gran capacidad de carga. La perfilera se suministra cortada a 45°. **IFRI** Le **connecteur d'angle** est facile à installer car il ne nécessite aucun perçage. Conçu pour empêcher la flexion de l'angle en raison de sa capacité de charge élevée. Les profilés sont fournis coupés à 45°.



IESI SOFTOP DOBLE: gracias a la **nueva tecnología de amortiguación** recientemente desarrollada, el **esfuerzo de apertura** será mínimo, ya que **se reduce hasta casi un 40%**. Asimismo, ofrece un frenado suave y silencioso en los últimos 7cm del recorrido de cierre. Para instalaciones con solo un mínimo de ancho puerta necesario de 630mm. **IENI DOUBLE SOFTOP:** thanks to the **latest developed damping technology**, the **opening effort** is minimal as **it has been reduced by almost 40%**. Likewise, a smooth and silent closing in the last 7cm of the sliding path is achieved. The double SofTop damping system protects the system from impact damage, thus extending the useful life of the product and with only a minimum door width of 630mm required. **IFRI SOFTOP DOBLE :** grâce à la **nouvelle technologie d'amortissement** récemment mise au point, **l'effort d'ouverture** est minimum et **réduit de près de 40%**. Il offre également un freinage en douceur et silencieux dans les 7 derniers centimètres du parcours de fermeture. Pour les installations où seule une largeur de porte minimale de 630mm est requise.

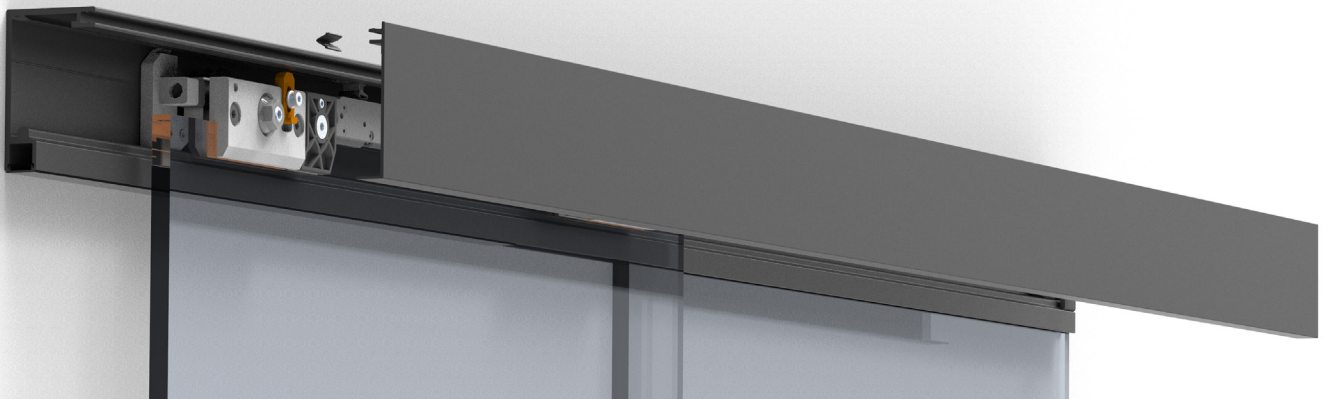

IESI Acceso frontal a todas las regulaciones y componentes. Tapeta con clipaje de apriete para ahorro de tiempo de instalación.
IENI Frontal access to all components and its adjustments and regulations. The lateral top cover track is clipped to save installation time.
IFRI Accès frontal à tous les réglages et composants. Bandeau de serrage à clipser pour une installation rapide.

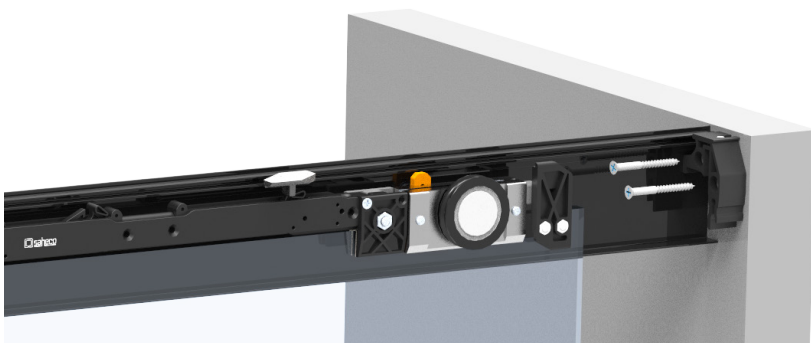

IESI Soportes flotantes a pared y vidrio ocultos. **IENI Hidden floating** wall and glass mounting **brackets.** **IFRI Supports muraux flottants** et verre dissimulé.





Diseño compacto, estilo minimal

Compact and sleek design | Design compact, style minimaliste

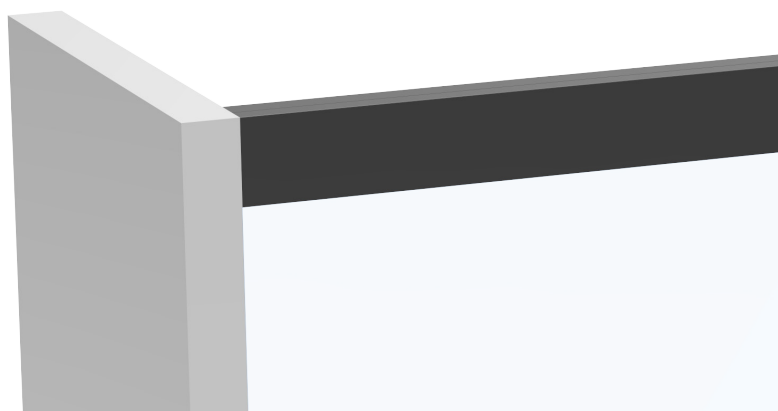

ES | Perfil liso y compacto (76x49mm) en distintos acabados disponibles que ofrece excelentes posibilidades de integración en cualquier tipo de diseño arquitectónico. **EN** | Smooth and compact track (76x49mm) in different finishes available that offers excellent possibilities for integration into any type of architectural design. **FR** | Profilé lisse et compact (76x49mm) en différentes finitions disponibles qui offre d'excellentes possibilités d'intégration dans tout type de conception architecturale.

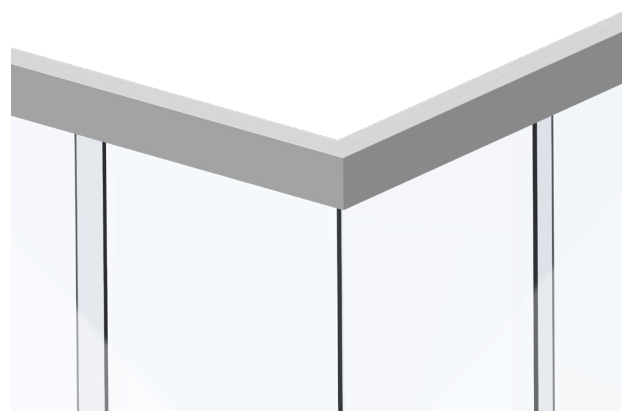

ES | Conector angular interno para la unión de los dos perfiles a 90°, dejando libre la superficie del perfil para un acabado limpio y lineal. **EN** | Internal angular connector for joining the two tracks at 90°, leaving the visible surface of the track with a clean and linear finish. **FR** | Connecteur d'angle interne pour joindre les deux profilés à 90°, laissant la surface du profilé libre pour une finition propre et linéaire.

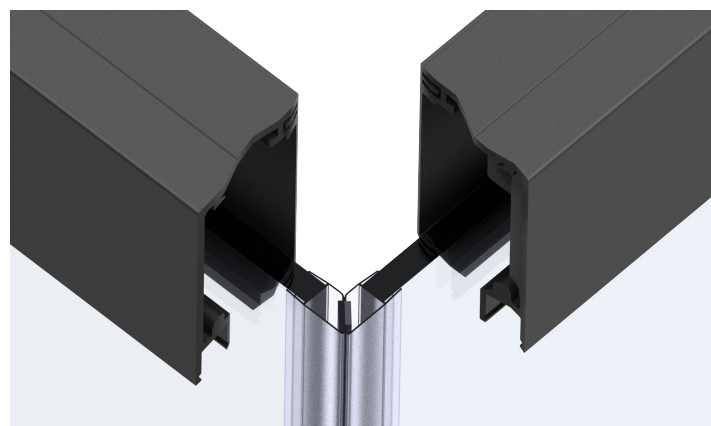
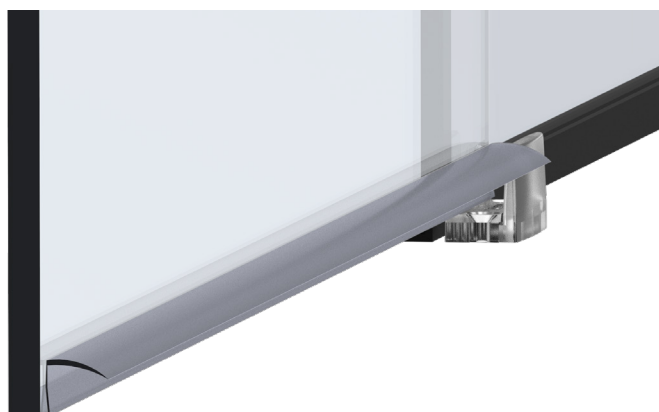

ES | Guiador de plástico transparente (resistente a los rayos UV) para una óptima estética visual. **Vierteaguas, salvacantos y juntas de estanqueidad disponibles**, de fácil quita y pon para limpiar y/o cambiar. **EN** | Transparent plastic bottom guide (resistant to UV rays) for optimal visual aesthetics. **Water seals, edge water seals and sealing gaskets available**, easy-to-remove for cleaning and/or changing. **FR** | Guide en plastique transparent (résistant aux UV) pour une esthétique visuelle optimale. **Gouttière, joints d'étanchéité et profilés de finition sont disponibles**, facile à enlever pour le nettoyage et/ou le remplacement.

Acabados disponibles

Available finishes | Finitions disponibles



Aluminio Inox repulido
Brushed nickel aluminium
Aluminium polie nickel
Brillante | Shiny | Brillant



Aluminio pulido cromado
Polished chrome aluminium
Aluminium polie chromé
Brillante | Shiny | Brillant



Aluminio dorado cepillado
Satin brass aluminium
Aluminium doré brossé
Brillante | Shiny | Brillant



Aluminio anodizado negro mate
Matt black anodized aluminium
Aluminium anodisé noir mat



Montaje vidrio-pared | mounting glass-to-wall | fixation verre-mur



Proyecto by Servicons Reformas & Interiorismo

Montaje pared-pared | mounting wall-to-wall | fixation mur-mur



Montaje pared-pared. Angular 90° | Mounting wall-to-wall. Angular 90° | Fixation mur-mur. Angulaire 90°



Variantes de instalación

Installation possibilities | Variantes d'installation

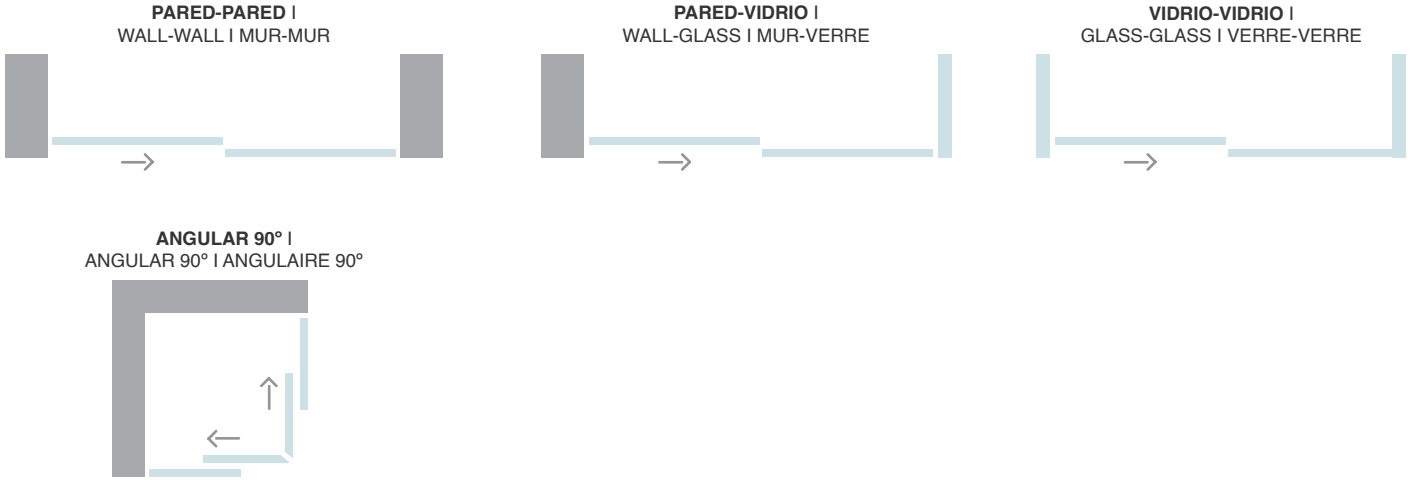

Sección tipo

Cross-section | Section type (Cotas en mm | Dimensions in mm | Dimensions en mm)

SV-X50 | SV-X50 | SV-X50

SV-X50 ANGULAR 90° | SV-X50 90° ANGLE | SV-X50 ANGLE 90°

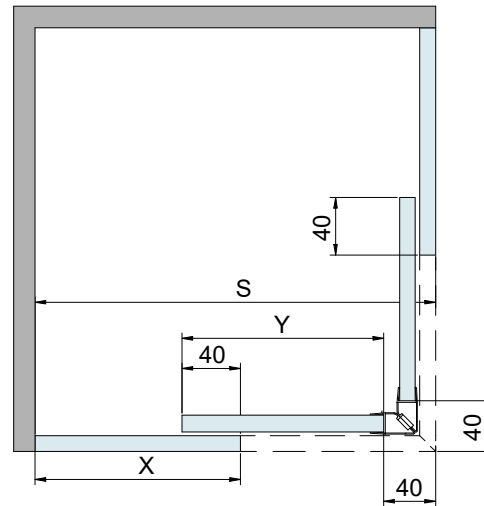
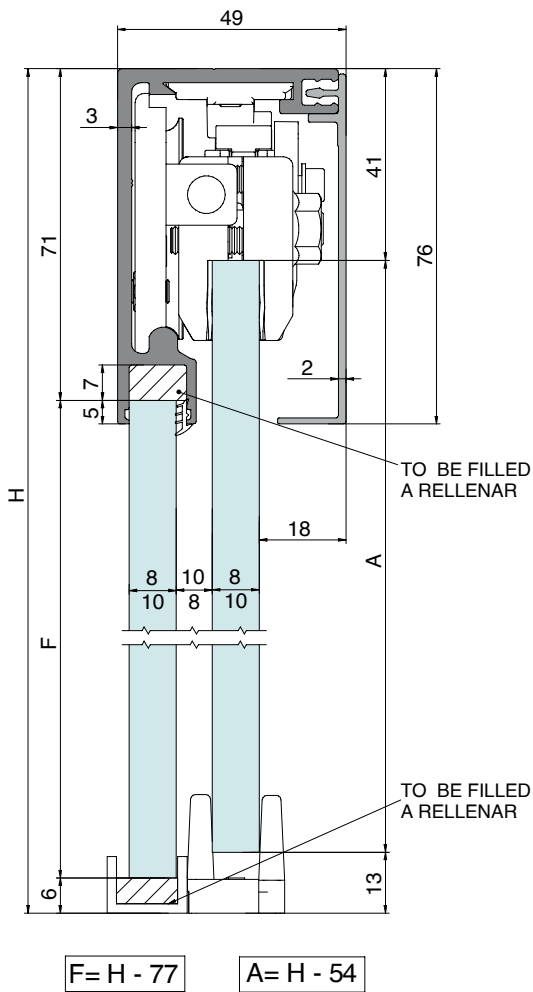

S=LONGITUD PERFIL / Track length / Longueur du profil

X= S/2

Y=X

ANGULAR 90° 90° CORNER ANGLE 90°		Plato de ducha Shower tray Receveur de douche	Ancho de puerta Door width Largeur de porte	Peso máximo Max. weight Maximum poids
Sin Softop Without Softop Sans Softop	Min.	900x900	450	30 kg
	Máx.	1500x1500	750	
Con Softop With Softop Avec Softop	Min.	1260x1260	630	
	Máx.	1500x1500	750	



Sección tipo

Cross-section | Section type (Cotas en mm | Dimensions in mm | Dimensions en mm)

SV-X50 ANGULAR 90° | SV-X50 90° ANGLE | SV-X50 ANGLE 90°

SECCIONES MÍNIMO ANCHO DE HOJA, OPCIÓN SOFTOP
 SECTION MINIMUM PANEL WIDTH, SOFTOP OPTION |
 SECTIONS LARGEUR MINIMUM DE VANTAUX, OPTION SOFTOP

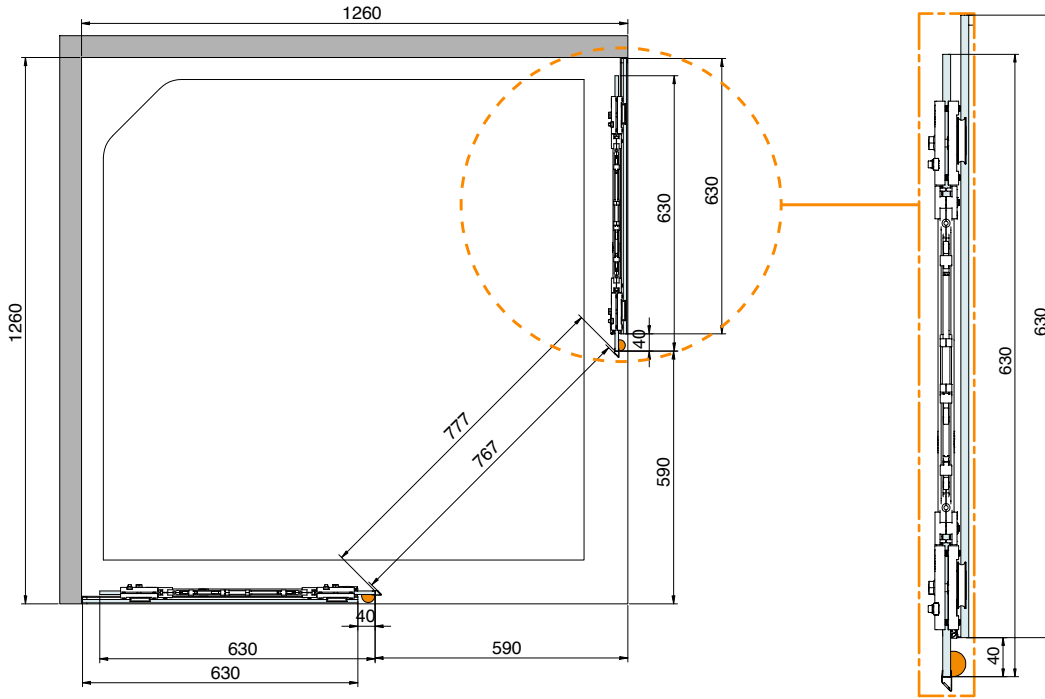

SECCIONES MÍNIMO ANCHO DE HOJA, OPCIÓN SIN SOFTOP
 SECTION MINIMUM PANEL WIDTH, OPTION WITHOUT SOFTOP |
 SECTIONS LARGEUR MINIMUM DE VANTAUX, OPTION SANS SOFTOP

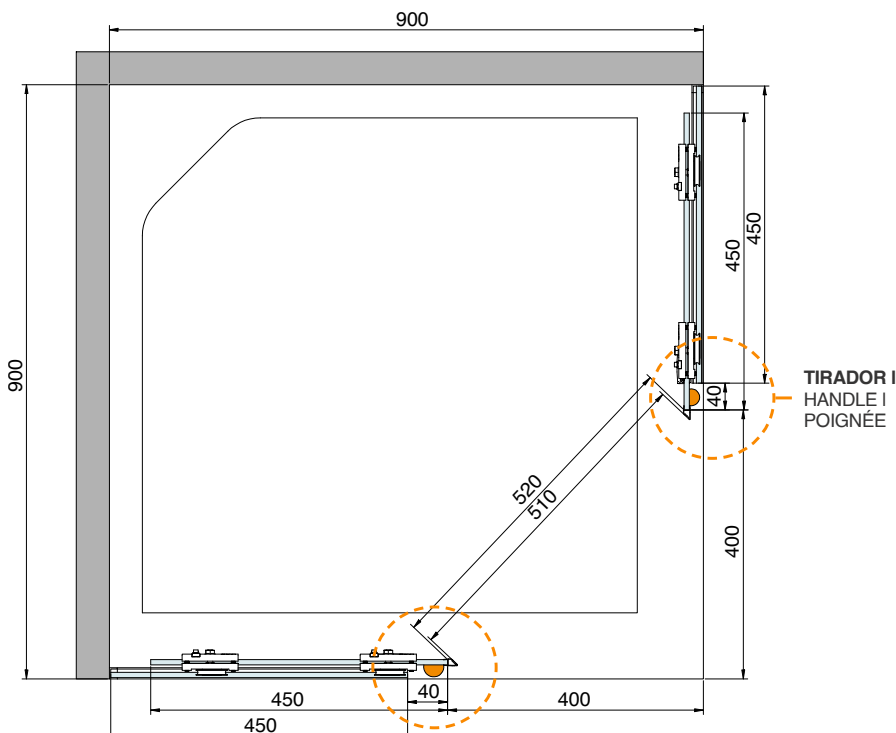



Componentes

Components | Composants

KITS KITS KITS		Acabado	Cód.		
	<p>Kit SV-X50. x2 Freno retenedor SV-X50 kit. x2 Retaining stopper Kit SV-X50. x2 Frein de retenue</p> <p>50kg </p> <p>RODAMIENTO A BOLAS BALL BEARING ROULEMENT À BILLES</p>	<p>BN 0 950 34</p> <p>PC 0 950 35</p> <p>SB 0 950 36</p> <p>BA 0 950 37</p>		2,13m	1 kit 1 jeu
	<p>Kit SV-X50 angular 90°. x2 Freno retenedor SV-X50 kit angular 90°. x2 Retaining stopper Kit SV-X50 angulaire 90°. x2 Frein de retenue</p> <p>30kg </p> <p>RODAMIENTO A BOLAS BALL BEARING ROULEMENT À BILLES</p>  <p>*Perfilería cortada a 45° Profiles cut at 45° Profils coupés à 45°</p>	<p>BN 0 950 38</p> <p>PC 0 950 39</p> <p>SB 0 950 40</p> <p>BA 0 950 41</p>		1,5m x2	1 kit 1 jeu
	<p>Kit SV-X50. x1 SofTop doble SV-X50 kit. x1 Double SofTop Kit SV-X50. x1 SofTop double</p> <p>50kg </p> <p>RODAMIENTO A BOLAS BALL BEARING ROULEMENT À BILLES</p>	<p>BN 0 950 20</p> <p>PC 0 950 21</p> <p>SB 0 950 22</p> <p>BA 0 950 23</p>		2,13m	1 kit 1 jeu
	<p>Kit SV-X50 angular 90°. x1 SofTop doble SV-X50 kit angular 90°. x1 Double SofTop Kit SV-X50 angulaire 90°. x1 SofTop double</p> <p>30kg </p> <p>RODAMIENTO A BOLAS BALL BEARING ROULEMENT À BILLES</p>  <p>*Perfilería cortada a 45° Profiles cut at 45° Profils coupés à 45°</p>	<p>BN 0 950 42</p> <p>PC 0 950 43</p> <p>SB 0 950 44</p> <p>BA 0 950 45</p>		1,5m x2	1 kit 1 jeu



Componentes

Components | Composants

ACCESORIOS ACCESSORIES ACCESSOIRES		Acabado	Cód.		
	<p>SofTop doble SV-X50 SV-X50 Double SofTop SofTop double SV-X50</p> <p>50kg</p>		0 950 32		1 pieza 1 piece 1 pièce
	<p>Soporte flotante vidrio fijo 90°. Izquierdo Fixed glass mounting bracket 90°. Left Support de montage sur verre fixe 90°. Gauche</p>	<p>BN</p> <p>PC</p> <p>SB</p> <p>BA</p>	<p>0 950 24</p> <p>0 950 25</p> <p>0 950 26</p> <p>0 950 27</p>		1 pieza 1 piece 1 pièce
	<p>Soporte flotante vidrio fijo 90°. Derecho Fixed glass mounting bracket 90°. Right Support de montage sur verre fixe 90°. Droit</p>	<p>BN</p> <p>PC</p> <p>SB</p> <p>BA</p>	<p>0 950 28</p> <p>0 950 29</p> <p>0 950 30</p> <p>0 950 31</p>		1 pieza 1 piece 1 pièce
	<p>Perfil inferior para vidrio fijo de 8-10mm Bottom track for fixed glass of 8-10mm Rail inférieur pour verre fixe 8-10mm</p> <p>17x12mm</p>	<p>BN</p> <p>PC</p> <p>SB</p> <p>BA</p>	<p>0 971 15</p> <p>0 971 16</p> <p>0 971 17</p> <p>0 971 18</p>	1,5m	1 perfil 1 profile 1 profil
	<p>Guiador inferior plástico para vidrio de 8-12mm Plastic bottom guide for glass of 8-12mm Guide inférieur plastique pour verre de 8-12mm</p>		00 40 57		25 piezas 25 pieces 25 pièces

BN Aluminio Inox repulido
 Brushed nickel aluminium
 Aluminium polie nickel
 Brillante | Shiny | Brillant

PC Aluminio pulido cromado
 Polished chrome aluminium
 Aluminium polie chromé
 Brillante | Shiny | Brillant









SB Aluminio dorado cepillado
 Satin brass aluminium
 Aluminium doré brossé
 Brillante | Shiny | Brillant

BA Aluminio anodizado negro mate
 Matt black anodized aluminium
 Aluminium anodisé noir mat

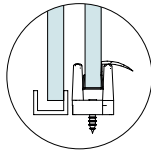

Componentes

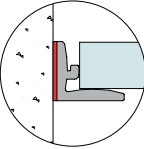

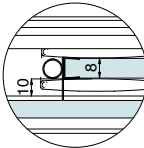



Components | Composants

ACCESORIOS ACCESSORIES ACCESSOIRES		Acabado	Cód.		
	<p>Viereteaguas SV-X50 SV-X50 Railing mount Eau gouttière SV-X50</p>  <p>14x25mm</p> 		0 950 46	2m	1 pieza 1 piece 1 pièce
	<p>Perfil plástico salvacantos corredera SV-X50 Edge water seal profile sliding door SV-X50 Profilé plastique de finition coulissant SV-X50</p>  <p>14x10mm</p>		00 86 30	3m	2 piezas 2 pieces 2 pièces
	<p>Salvacantos de cierre vidrio-pared SV-X50 Edge water seal for closing glass-to-wall SV-X50 Profilé de finition de fermeture verre-mur SV-X50</p>  <p>13x15mm</p> <p>*Se suministra con cinta adhesiva de doble cara Served with double-sided adhesive tape Est servi avec du ruban adhésif double face</p> 		0 950 48	2,13m	1 pieza 1 piece 1 pièce
	<p>Salvacantos entre vidrios SV-X50 Between glasses water seal SV-X50 Profilé de finition entre les vitres SV-X50</p>  <p>8x20mm</p> <p>*Solo para 8mm de grosor de vidrio Only for 8mm thick glass Uniquement pour verre de 8 mm d'épaisseur</p> 		0 950 33	3m	1 pieza 1 piece 1 pièce

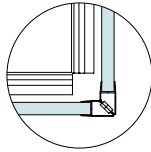

Componentes

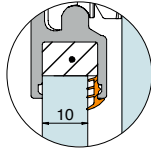
Components | Composants

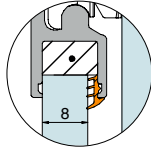
ACCESORIOS ACCESSORIES ACCESSOIRES		Acabado	Cód.		
	<p>Juego salvacantos 90/180° imantado SV-X50 Edge water seal set magnetized for 90/180° SV-X50 Jeu de profilés de finition magnétiques 90/180° SV-X50</p>  <p>21x10mm</p> 		0 950 47	2,2m x2	1 pieza 1 piece 1 pièce
	<p>Junta transparente PVC 2mm PVC profile gasket 2mm Joint d'adaptation PVC 2mm</p>  <p>6x3mm</p> 	<p> PVCT</p> <p> PVCB</p>	00 45 82 00 45 83	1m	1 pieza 1 piece 1 pièce
	<p>Junta transparente PVC 4mm PVC profile gasket 4mm Joint d'adaptation PVC 4mm</p>  <p>9x5mm</p> 	<p> PVCT</p> <p> PVCB</p>	00 45 84 00 45 85	1m	1 pieza 1 piece 1 pièce

Vaho Glass

SV-X50



Polígono Industrial de Foradada / 08580
St. Quirze de Besora / Barcelona / Spain
T +34 93 852 92 23
saheco@saheco.com

Export contact details
T +34 93 852 96 15
export@saheco.com
saheco.com



BG Glass Solutions Inc.
167 Suffolk Street West
Guelph, ON. N1H 2J7
info@barberglass.ca