



Multiplo Compact Glass

SV-SINCRO X110

MULTIPL COMPACT GLASS

BIBLIOTECA
DE DESCARGAS



DOWNLOADS LIBRARY |
BIBLIOTHÈQUE
TÉLÉCHARGEMENTS

ES

LA FAMILIA MULTIPL COMPACT GLASS ES LA MEJOR OPCIÓN PARA CERRAR ESPACIOS GRANDES CON MÚLTIPLES HOJAS DE VIDRIO.

El sistema SV-Sincro X110 permite abrir y cerrar dos hojas de forma simultánea y sincronizada en los dos lados, con la posibilidad de instalar 2 hojas de hasta 110kg.

Además, incorpora como novedad la tecnología **SOFTPRO** de Saheco, una característica que aporta mayor suavidad y seguridad en la apertura y en el cierre de la instalación.

EN

THE MULTIPL COMPACT GLASS FAMILY IS THE BEST CHOICE FOR CLOSING LARGE SPACES WITH MULTIPLE GLASS SHEETS WITH AN ATTRACTIVE MINIMALIST DESIGN.

The SV-Sincro X110 system allows you to open and close two sheets simultaneously and synchronized on both sides, with the possibility of installing 2 sheets of up to 110kg.

In addition, it incorporates as a novelty **SOFTPRO** technology by Saheco, a feature that brings greater smoothness and safety in the opening and closing of the installation.

FR

LA FAMILLE MULTIPL COMPACT GLASS, EST LA MEILLEURE OPTION POUR FERMER DE GRANDS ESPACES AVEC DE MULTIPLES PANNEAUX DE VERRE ET AVEC UN ATTRAYANT DESSIN MINIMALISTE.

Le système SV-Sincro X110 permet ouvrir et fermer deux feuilles simultanément et de manière synchrone sur les deux côtés, et avec la possibilité d'installation des deux feuilles jusqu'à 110 kg.

Il est équipée de la nouvelle fonctionnalité de la technologie **SOFTPRO** Saheco, une fonctionnalité qui vous donne la sécurité et douceur dans l'ouverture et la fermeture de l'installation.





Características técnicas

Technical characteristics | Caractéristiques techniques

Perfilería Profiles | Profils



FT VIDRIO FIJO
I FIXED GLASS
I VERRE FIXE



Especificaciones Specifications | Spécification

VIDRIO FIJO I FIXED
GLASS I VERRE FIXE
(Techo I Ceiling I
Plafond)



VIDRIO FIJO I FIXED
GLASS I VERRE FIXE
(FT)



PARED DE VIDRIO
I GLASS WALL
I MUR DE VERRE



MÁX. 110Kg



RODAMIENTO A BOLAS
BALL BEARING
ROULEMENT À BILLES



KIT DISPONIBLE
I AVAILABLE

Peso Weight | Poids

110 kg

242 lb

Producto certificado

Certificated product | Produit certifié





SOFTPRO®

TECHNOLOGY by Saheco

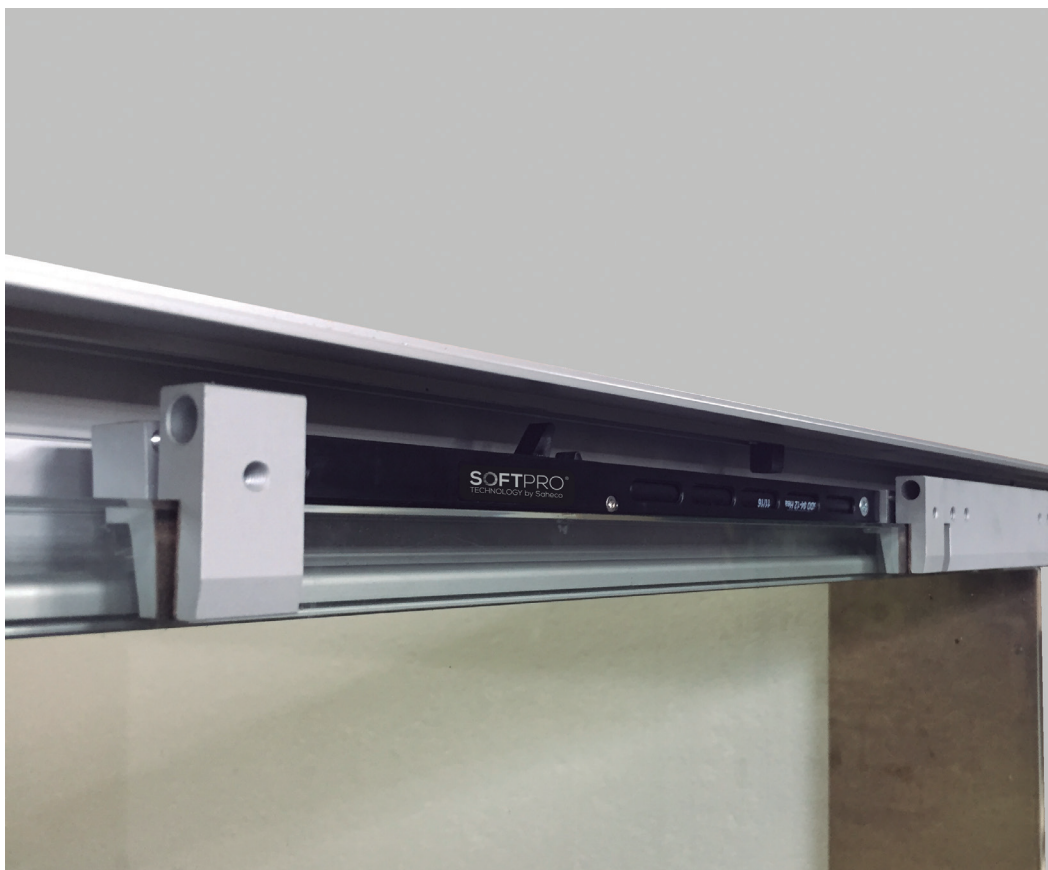

La nueva tecnología **SOFTPRO**® de frenado suave combina la función de dos pistones a gas y un amortiguador de aceite en un único componente.

Ofrece 4 funciones distintas:

- 1.** Velocidad de cierre ajustable.
- 2.** El cierre es progresivo y se ralentiza cuando la puerta se acerca a la posición completamente cerrada.
- 3.** Cierre suave.
- 4.** Enganche resistente a la rotura.

Garantiza un frenado seguro y evita el rebote de la puerta.

Proporciona un movimiento armónico y una amortiguación segura del cierre de la puerta hasta 110 kg.

SOFTPRO® the new soft-closing technology from SAHECO which combines two nitrogen gas filled pistons and one oil filled piston all within the same unit.

Features:

- 1.** Fully adjustable closing speed.
- 2.** Closing action is progressive and slows down as the door approaches the fully closed position.
- 3.** Soft Closing.
- 4.** Anti break feature on the trigger.

Ensures safe braking and Prevents bouncing of the door.

Combines an aesthetically pleasing action with safe soft closing for door weights up to 110Kgs.

La nouvelle technologie de freinage **SOFTPRO**® fonctionne grâce à la combinaison de deux pistons à gaz et un amortisseur à huile.

Offre 4 types de fonctions:

- 1.** Ajustement flexible.
- 2.** Frein progressive.
- 3.** Freinege douce.
- 4.** Crochet anti-rupture.

Garanti un freinage fiable évitant le refoulement de la porte.

Apporte un mouvement esthétique et un amortissement fiable de fermeture de porte jusqu'à 110kg.



SOFTPRO[®]

TECHNOLOGY by Saheco

CARACTERÍSTICAS

SOFTPRO[®]

Frenado progresivo de los últimos 65mm de recorrido de la puerta, para hojas de hasta 110kg.

FEATURES

SOFTPRO[®]

Progressive soft closing for the last 65mm of the doors travel into the fully closed position for door weights up to a maximum of 110Kgs.

CARACTÉRISTIQUES

SOFTPRO[®]

Freinage progressif de derniers 65mm de parcours de la porte, pour panneaux jusqu'à 110kg.

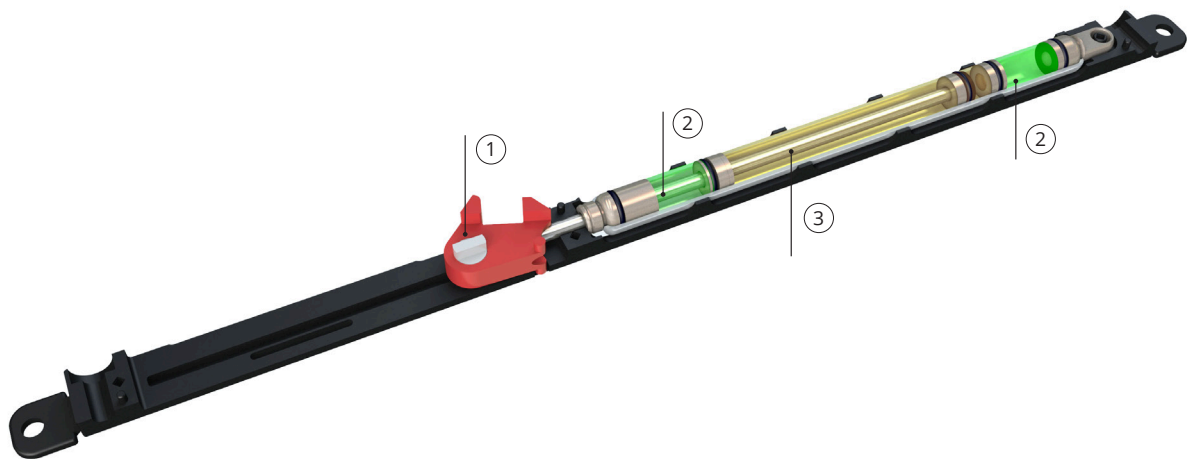

①

Enganche resistente a la rotura
Anti break trigger | Crochet anti rupture

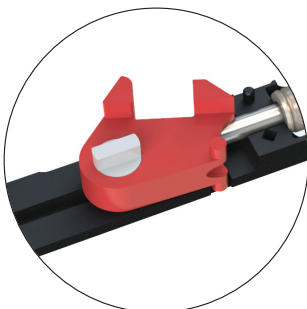

②

Cámara de nitrógeno
Nitrogen gas filled pistons | Chambre azote

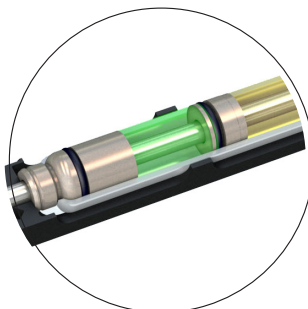

③

Cámara de amortiguación en aceite
Oil filled piston | Piston amortisseur à huile

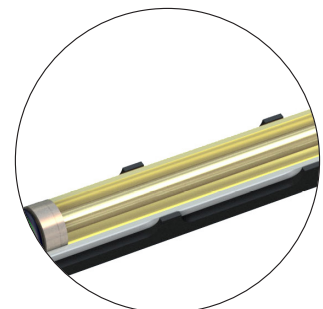

Variantes de instalación

Installation possibilities | Variantes d'installation

PARED
WALL
MUR

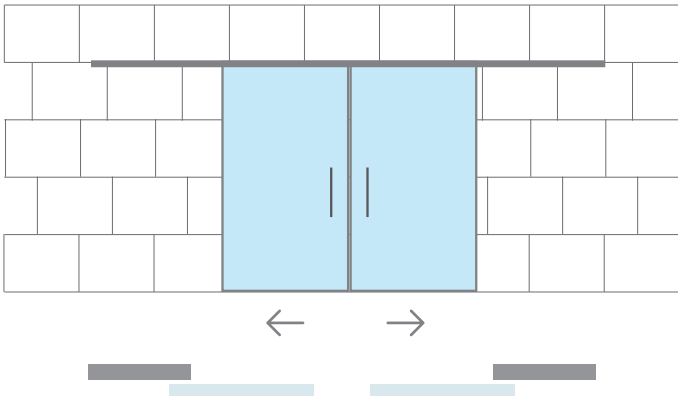

PARED CON VIDRIO FIJO
WALL WITH FIXED PANEL
MUR AVEC VERRE FIXE

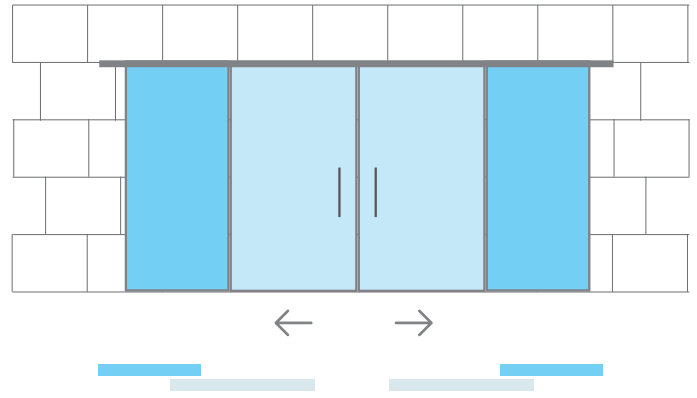

TECHO
CEILING
PLAFOND

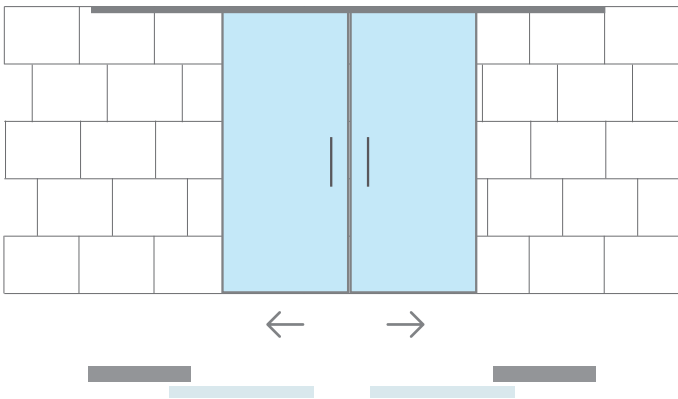

TECHO CON VIDRIO FIJO
CEILING WITH FIXED PANEL
PLAFOND AVEC VERRE FIXE

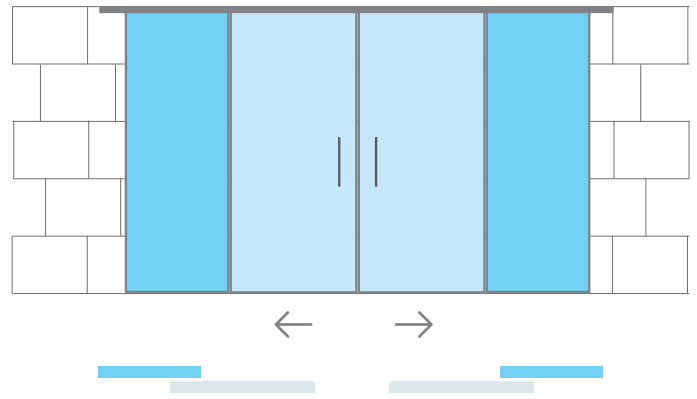

FALSO TECHO
FALSE CEILING
FAUX PLAFOND

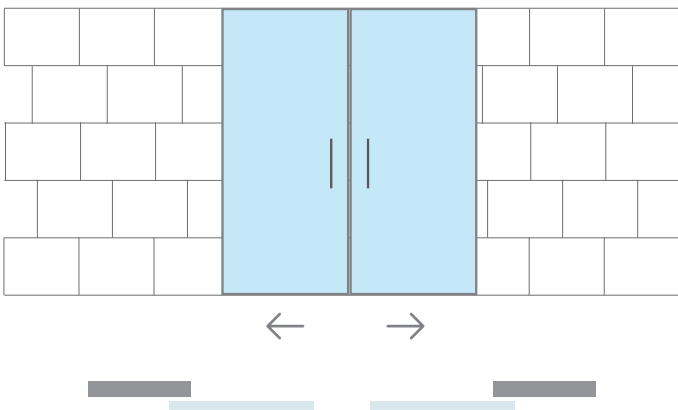

FALSO TECHO CON VIDRIO FIJO
FALSE CEILING WITH FIXED GLASS
FAUX PLAFOND AVEC VERRE FIXE

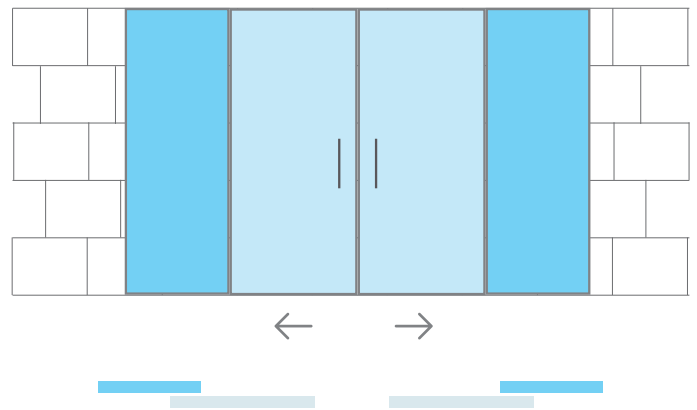

 PUERTA CORREDERA
SLIDING DOOR / PORTES COULISSANTES

 VIDRIO FIJO
FIXED GLASS / VERRE FIXE



Sección tipo

Cros-section | Section type (Cotas en mm | Dimensions in mm | Dimensions en mm)

MONTAJE A PARED | WALL MOUNTING | FIXATION À MUR

MONTAJE A TECHO | CEILING MOUNTING | FIXATION À PLAFOND

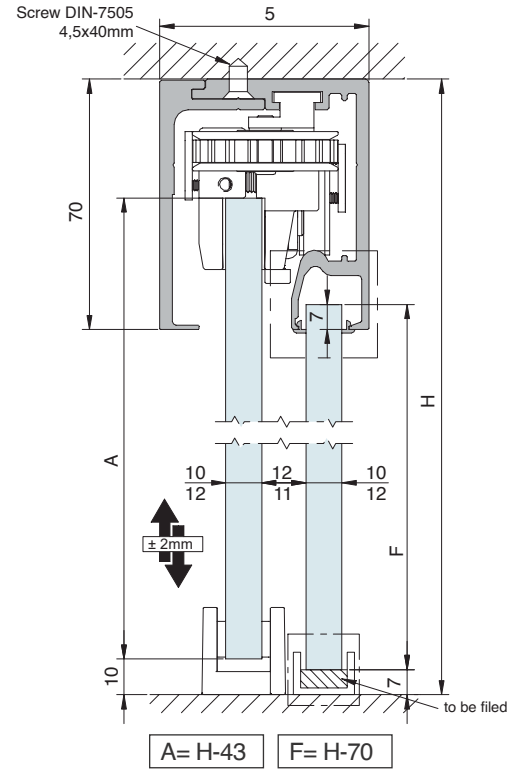
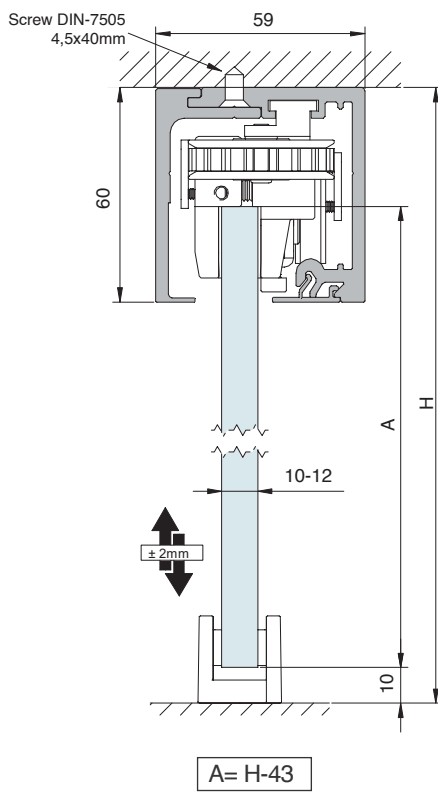
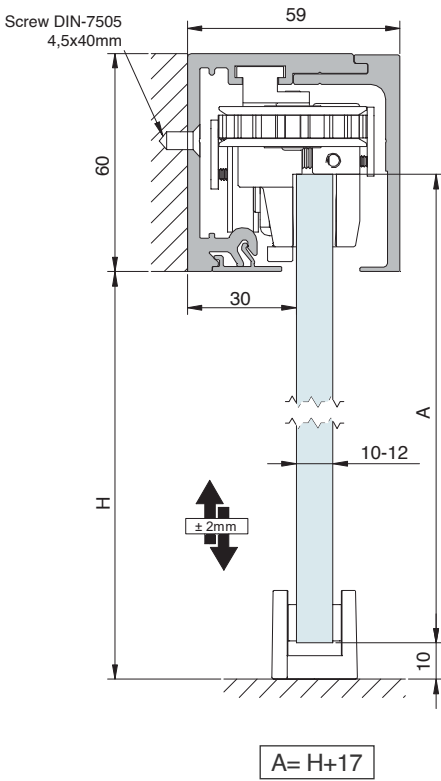



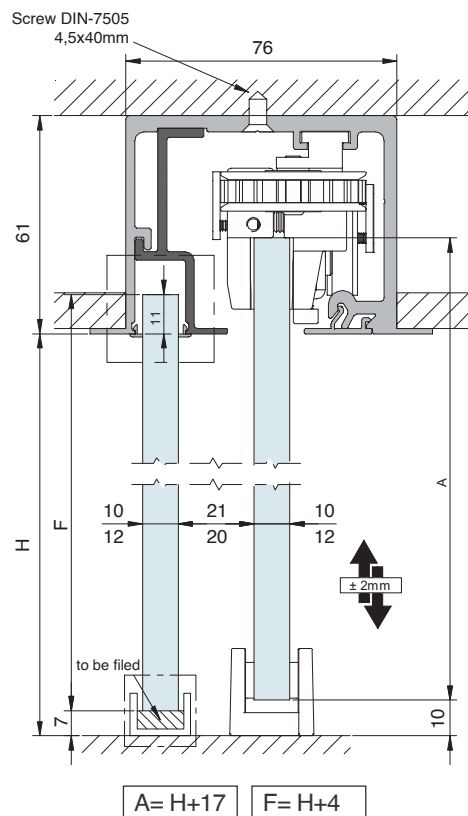
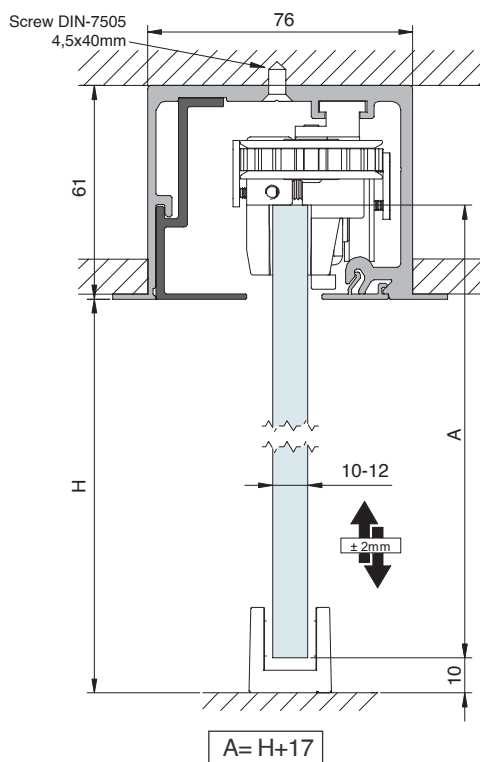



MONTAJE A FALSO TECHO | FALSE CEILING MOUNTING | FIXATION À FAUX-PLAFOND



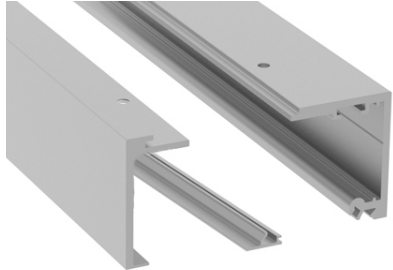

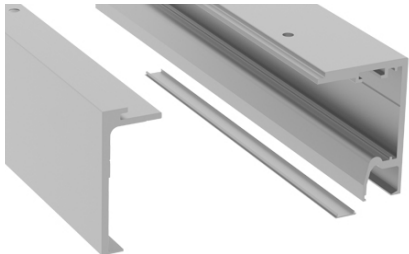
Componentes

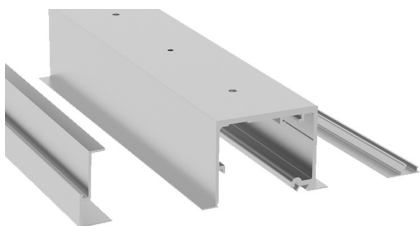
Components | Composants

PERFILERÍA PROFILES PROFILS	Acabado	Cód.		
 <p>Conjunto perfil superior corredero Sliding top track set Jeu rail supérieur coulissant</p>  <p>59x60mm</p>	S	0 109 20	2 m	1 juego 1 set 1 jeu
		0 109 30	3 m	
		0 109 40	4 m	
		0 109 60	6 m	
	WL	0 119 20	2 m	
		0 119 30	3 m	
		0 119 40	4 m	
		0 119 60	6 m	
	BL	0 119 24	2 m	
		0 119 34	3 m	
		0 119 44	4 m	
		0 119 64	6 m	
 <p>Conjunto perfil superior corredero para vidrio fijo Sliding top track set for fixed glass Jeu rail supérieur coulissant pour verre fixe</p>  <p>59x70mm</p>	S	0 109 22	2 m	1 juego 1 set 1 jeu
		0 109 32	3 m	
		0 109 42	4 m	
		0 109 62	6 m	
	WL	0 119 21	2 m	
		0 119 31	3 m	
		0 119 41	4 m	
		0 119 61	6 m	
	BL	0 119 25	2 m	
		0 119 35	3 m	
		0 119 45	4 m	
		0 119 65	6 m	
 <p>Conjunto perfil superior corredero FT. Montaje a falso techo FT sliding top track set. False ceiling mounting Set rail supérieur coulissant FT. Fixation à faux plafond</p>  <p>76x61mm</p>	S	0 109 24	2 m	1 juego 1 set 1 jeu
		0 109 34	3 m	
		0 109 44	4 m	
		0 109 64	6 m	
	WL	0 119 22	2 m	
		0 119 32	3 m	
		0 119 42	4 m	
		0 119 62	6 m	
	BL	0 119 26	2 m	
		0 119 36	3 m	
		0 119 46	4 m	
		0 119 66	6 m	

S Aluminio anodizado plata mate
Satin anodized aluminium
Aluminium anodisé argent











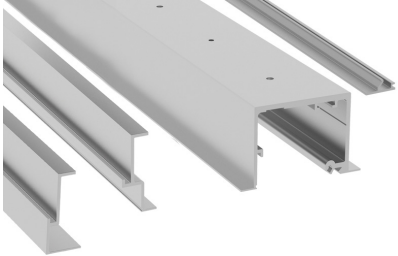

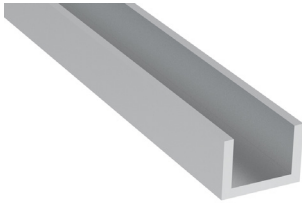
BL Aluminio lacado negro mate
Matt black lacquered aluminium
Aluminium anodisé laqué noir mat

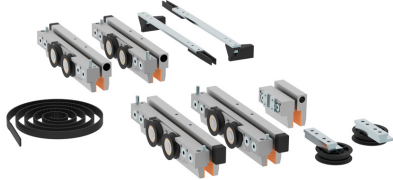
WL Aluminio lacado blanco mate
Matt white lacquered aluminium
Aluminium anodisé laqué blanc mat



Componentes





Components | Composants

PERFILERÍA PROFILES PROFILS		Acabado	Cód.						
 <p>Conjunto perfil superior corredero FT para vidrio fijo. Montaje a falso techo FT sliding top track for fixed glass set. False ceiling mounting Set rail supérieur coulissant pour verre fixe. Fixation à faux plafond</p>  <p>76x61mm</p>	S	0 109 26 0 109 36 0 109 46 0 109 66	2 m 3 m 4 m 6 m	1 juego 1 set 1 jeu					
	WL	0 119 23 0 119 33 0 119 43 0 119 63	2 m 3 m 4 m 6 m						
	BL	0 119 27 0 119 37 0 119 47 0 119 67	2 m 3 m 4 m 6 m						
	 <p>Perfil inferior para vidrio fijo de 8-10-12mm Bottom track for fixed glass of 8-10-12mm Rail inférieur pour verre fixe 8-10-12mm</p>  <p>17x12mm</p>	S	00 87 24 00 87 34 00 87 64		2 m 3 m 6 m	1 perfil 1 profile 1 profil			
		WL	00 71 96 00 71 91 00 71 97		2 m 3 m 6 m				
		BL	00 71 86 00 71 81 00 71 87		2 m 3 m 6 m				
		JUEGOS SETS JEUX			Acabado		Cód.		
		 <p>Juego accesorios SV-Sincro X110 x2 Freno retenedor SV-Sincro X110 Fitting set x2 Retaining stopper Garniture SV-Sincro X110 x2 Frein de retenue</p> <p>110kg por hoja per panel par panneaux</p>  <p>RODAMIENTO A BOLAS BALL BEARING ROULEMENT À BILLES</p>			0 109 08			1 juego 1 set 1 jeu	
			 <p>Juego accesorios SV-Sincro X110 x2 SOFTPRO 55kg SV-Sincro X110 Fitting set x2 SOFTPRO 55kg Garniture SV-Sincro X110 x2 SOFTPRO 55kg</p> <p>55kg por hoja per panel par panneaux</p>   <p>RODAMIENTO A BOLAS BALL BEARING ROULEMENT À BILLES</p>				0 109 06		1 juego 1 set 1 jeu
					 <p>Juego accesorios SV-Sincro X110 x2 SOFTPRO doble 110kg SV-Sincro X110 Fitting set x2 double SOFTPRO 110kg Garniture SV-Sincro X110 x2 SOFTPRO double 110kg</p> <p>110kg por hoja per panel par panneaux</p>   <p>RODAMIENTO A BOLAS BALL BEARING ROULEMENT À BILLES</p>			0 109 07	

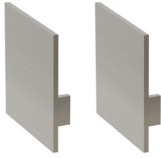
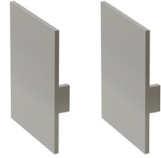
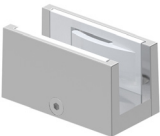

Componentes

Components | Composants

ACCESORIOS ACCESSORIES ACCESSOIRES		Acabado	Cód.	Longitud	Icono
	<p>Juego de tapas laterales para perfil superior. Montaje a techo o pared Lateral cap set for top track. Ceiling or wall mounting Jeu de capuchons latéraux pour rail supérieur. Fixation à mur et à plafond</p>	PPS	0 109 90		<p>1 juego 1 set 1 jeu</p>
		PPSS	0 109 91		
		PPW	0 119 93		
		PPB	0 119 95		
	<p>Juego de tapas laterales para perfil superior para vidrio fijo. Montaje a techo o pared Lateral cap set for top track for fixed glass. Ceiling or wall mounting Jeu de capuchons latéraux pour rail supérieur pour verre fixe. Fixation à mur et à plafond</p>	PPS	0 109 92		<p>1 juego 1 set 1 jeu</p>
		PPSS	0 109 93		
		PPW	0 119 94		
		PPB	0 119 96		
	<p>Guiador inferior para vidrio de 8-14 mm Bottom guide for glass of 8-14mm Guide inférieur pour verre de 8-14mm</p>	S	0 155 73		<p>1 pieza 1 piece 1 pièce</p>
		WL	00 71 90		
		BL	00 71 80		
	<p>Junta transparente PVC 2mm PVC profile gasket 2mm Joint d'adaptation PVC 2mm</p>  <p>6x3mm</p>	PVCT	00 45 82	1 m	<p>1 pieza 1 piece 1 pièce</p>
		PVCB	00 45 83		
	<p>Junta transparente PVC 3mm PVC profile gasket 3mm Joint d'adaptation PVC 3mm</p>		00 45 87	1 m	<p>1 pieza 1 piece 1 pièce</p>
	<p>Tornillería sujeción 1 metro de perfil Bolts for securing 1 metre of track Vis de fixation 1 mètre de rail</p>		0 160 73		<p>1 juego 1 set 1 jeu</p>



PPSS Plástico pintado Inox
Plastic painted Stainless Steel
Plastique finition peinture Inox



PPW Plástico pintado blanco
Plastic painted white
PVC finition peinture blanche



PPB Plástico pintado negro
Black painted plastic
PVC peinture noir



PPS Plástico pintado plata
Plastic painted silver
PVC finition peinture argent



BL Aluminio lacado negro mate
Matt black lacquered aluminium
Aluminium anodisé laqué noir mat



WL Aluminio lacado blanco mate
Matt white lacquered aluminium
Aluminium anodisé laqué blanc mat



PVCT PVC transparente
Transparent PVC
PVC transparent



PVCB PVC negro
Black PVC
PVC noir











S Aluminio anodizado plata mate
Satin anodized aluminium
Aluminium anodisé argent



Componentes

Components | Composants

KITS KITS KITS	Acabado	Cód.	Largo	Cantidad
 <p>Kit SV-Sincro X110 x2 Freno retenedor SV-Sincro X110 kit x2 Retaining stopper Kit SV-Sincro X110 x2 Frein de retenue</p> <p>110kg por hoja per panel par panneaux</p>  59x60mm  RODAMIENTO A BOLAS BALL BEARING ROULEMENT À BILLES 	S	0 910 25 0 910 27	3 m 4 m	1 kit 1 jeu
 <p>Kit SV-Sincro X110 SOFTPRO® 55kg SV-Sincro X110 kit SOFTPRO® 55kg Kit SV-Sincro X110 SOFTPRO® 55kg</p> <p>55kg por hoja per panel par panneaux</p>  59x60mm  RODAMIENTO A BOLAS BALL BEARING ROULEMENT À BILLES  SOFTPRO 	S	0 910 29 0 910 31	3 m 4 m	1 kit 1 jeu
 <p>Kit SV-Sincro X110 x2 SOFTPRO® doble 110kg SV-Sincro X110 kit x2 double SOFTPRO® 110kg Kit SV-Sincro X110 x2 SOFTPRO® double 110kg</p> <p>110kg por hoja per panel par panneaux</p>  59x60mm  RODAMIENTO A BOLAS BALL BEARING ROULEMENT À BILLES  SOFTPRO 	S	0 910 59	4 m	1 kit 1 jeu

Componentes

Components | Composants

KITS KITS KITS		Acabado	Cód.		
	<p>Kit SV-Sincro X110 para vidrio fijo x2 Freno retenedor SV-Sincro X110 kit for fixed glass x2 Retaining stopper Kit SV-Sincro X110 pour verre fixe x2 Frein de retenue</p> <p>110kg por hoja per panel par panneaux</p>  59x70mm  RODAMIENTO A BOLAS BALL BEARING ROULEMENT À BILLES 	S	0 910 33 0 910 35	3 m 4 m	1 kit 1 jeu
	<p>Kit SV-Sincro X110 para vidrio fijo x2 SOFTPRO 55kg SV-Sincro X110 kit for fixed glass x2 SOFTPRO 55kg Kit SV-Sincro X110 pour verre fixe x2 SOFTPRO 55kg</p> <p>55kg por hoja per panel par panneaux</p>  59x70mm  RODAMIENTO A BOLAS BALL BEARING ROULEMENT À BILLES  SOFTPRO 	S	0 910 37 0 910 39	3 m 4 m	1 kit 1 jeu
	<p>Kit SV-Sincro X110 para vidrio fijo x2 SOFTPRO doble 110kg SV-Sincro X110 kit for fixed glass x2 double SOFTPRO 110kg Kit SV-Sincro X110 pour verre fixe x2 SOFTPRO double 110kg</p> <p>110kg por hoja per panel par panneaux</p>  59x70mm  RODAMIENTO A BOLAS BALL BEARING ROULEMENT À BILLES  SOFTPRO 	S	0 910 63	4 m	1 kit 1 jeu

Multiple Compact Glass

SV-SINCRO X110



Polígono Industrial de Foradada / 08580
St. Quirze de Besora / Barcelona / Spain
T +34 93 852 92 23
saheco@saheco.com

Export contact details
T +34 93 852 96 15
export@saheco.com
saheco.com



BG Glass Solutions Inc.
167 Suffolk Street West
Guelph, ON. N1H 2J7
info@barberglass.ca